

Fundamentals of
Fiber Optics
An Introduction for Beginners

Reinhard Jenny, M.S. Physics

translated:
Scott Kittelberger, M.S. Physics

Volpi AG
Wiesenstrasse 33
CH 8952 Schlieren
www.volpi.ch

Volpi Manufacturing USA Co., Inc.
5 Commerce Way
Auburn, NY 13210
www.volpiusa.com

Contents

1 Historical Overview

2 Fundamentals of Light Propagation in Light Guides

- 2.1 Total Internal Reflection
- 2.2 Numerical Aperture of a Light Guide
- 2.3 Guided Light Outside the Core Medium
- 2.4 Phase Shift of Total Reflection

3 Light Guides - Modes

- 3.1 Mode Equation
- 3.2 Mode Number of a Light Guide

4 Light Intensity Distribution in a Light Guide

5 Fundamentals and Properties of Optical Fibers

- 5.1 Fiber Types
- 5.2 Loss Mechanisms in Fibers
 - 5.2.1 Material Absorption
 - 5.2.2 Material Scattering
 - 5.2.3 Light Guide Specific Scattering Mechanisms
 - 5.2.4 Radiation Losses due to Macrobending
 - 5.2.5 Losses due to Microbending
 - 5.2.6 Fiber Coupling Losses

6 Transit Time Behaviour of Light in Light Guide

- 6.1 Mode Dispersion
 - 6.2.1 Material Chromatic Dispersion
 - 6.2.2 Propagation Chromatic Dispersion

7 Emitted Mode Radiation of Fibers

8 Properties of Fiber Bundles

- 8.1 Emitted Radiation Characteristics of Bundles
- 8.2 Bundle Losses
- 8.3 Fiber Bundle Transmission

9 Fiber Optic Illumination

- 9.1 Transforming Light Distribution
- 9.2 Fibers as Isolators
- 9.3 Partitioning Luminous Flux with Fibers
- 9.4 Fiber Optic Sensor Application

10 Overview of Common Fibers

- 10.1 Fiber for Producing Fiber Bundles
- 10.2 Single Fibers or Monofibers for Spectroscopy, Laser Light Propagation etc.
- 10.3 Fiber for Image Transmission

1 Historical Overview

The first attempts at guiding light on the basis of total internal reflection in a medium dates to 1841 by *Daniel Colladon*. He attempted to couple light from an arc lamp into a stream of water (Fig. 1).

Several decades later, the medical men *Roth* and *Reuss* used glass rods to illuminate body cavities (1888).

At the beginning of the 20th century light was successfully transmitted through thin glass fibers.

In 1926 *J.L. Baird* received a patent for transmitting an image in glass rods and *C.W. Hansell* first began contemplating the idea of configuring an imaging bundle.

In 1930 the medical student *Heinrich Lamm* of Munich produced the first image transmitting fiber bundle.

In 1931 the first mass production of glass fibers was achieved by *Owens – Illinois* for Fiberglas.

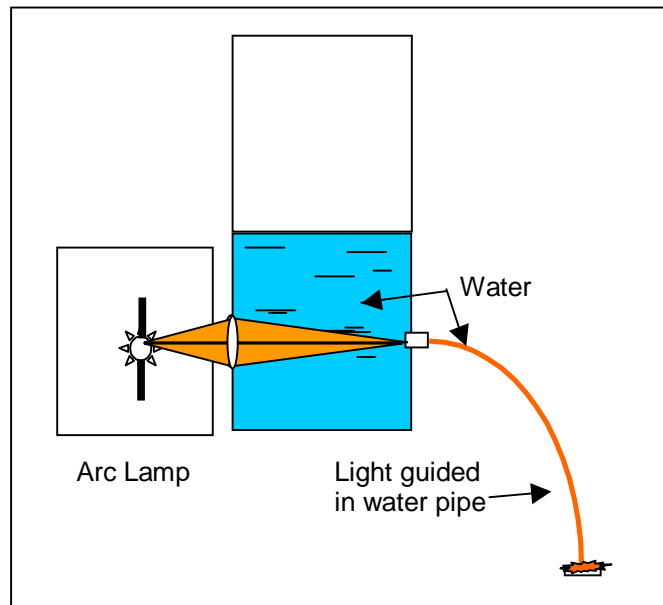

Fig. 1 : Historic attempt of D. Colladon to guide light in a stream of water (Geneva, 1841)

Attempts at patenting the idea of glass fibers with an enveloping clad glass was initiated by *H.M. Moller* in a patent by *Hansell*, however, refused. As a result the well-known scientists *A.C.S. van Heel*, *Kapany* and *H.H. Hopkins* produced the first fiber optic endoscope on the basis of fiber cladding in 1954.

Curtiss developed an important requisite for the production of unclad glass fibers in 1956. He suggested that a glass rod be used as the core material with a glass tube of lower index of refraction melted to it on the outside.

In 1961, *E. Snitzer* described the theoretical basis for very thin (several micron) fibers, which are the foundation for our current fiber optic communication network.

The notion of launching light into thin films was suggested by von *Karbowiak* in 1963

In 1967, *S. Kawakami* proposed the concept of fiber whose index of refraction varied in a continuous, parabolic manner from the center to the edge (gradient index fiber).

The main thrust of further activities in the development of fiber optics was in improving material quality of glass. High levels of purity were required of preform to address the enormous economic and technological potential of a worldwide communications network.

2 Fundamentals of Light Propagation in Light Guides

Fiber Optic light guides are media whose transverse dimension (diameter, thickness) can be very small, typically 10 μ m to 1 mm. They are very flexible and can be produced in virtually any

desired length. The material is usually glass, quartz or plastic. For special applications, other exotic materials such as liquid light guides, sapphire, fluoride or calcogenide may be used.

There are some unavoidable requirements for good light transmission, such as pure glass materials for the core and cladding and high transparency for the spectrum of interest. Minimal optical dispersion is also desired. Process parameters such as glass transformation temperature, viscosity, inclusions and chemical affinity dictate the economics and quality of the fiber product.

Light launched into a fiber will after a given length reach the core material boundary and pass to another medium (glass, air, etc.). Depending on the incident angle, some of the energy will be refracted outward (**leaky modes**) and some will reflect back into the core material (Figure 2).

2.1 Total Internal Reflection

When the outer medium is less optically dense (lower index of refraction) than the core material, there is a distinct angle for which no light is refracted (Figure 3). Light is completely reflected back into the core material (**Total Internal Reflection**).

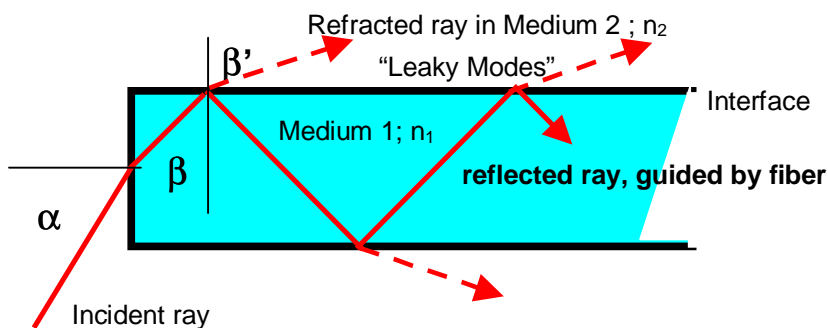

Fig 2.: Light transmission in Medium with $n_1 > n_2$

Maximum light can only be transmitted through the light guide if total internal reflection occurs at the core-clad interface. In this case, $\beta > \beta_{Min}$, where β_{Min} is the angle of incidence for which $\beta' = 90^\circ$.

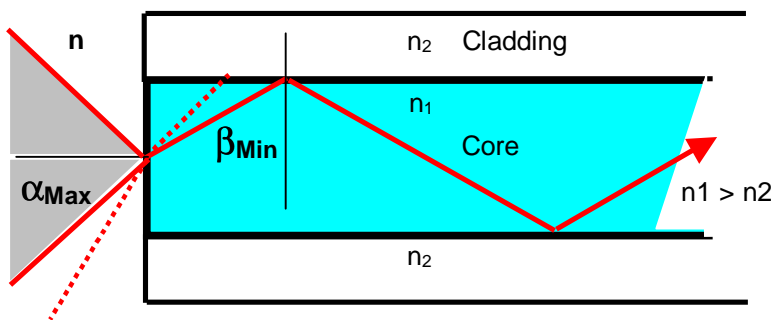

Fig. 3: Light transmission Medium n_1 with total reflection of the transmitted ray; The light guide has a cladding material n_2 ; $n \dots$ Index of refraction for the coupling medium (usually air; $n = 1$)

2.2 Numerical Aperture of a Light Guide

Per the law of refraction, total reflection at the core/clad interface obeys:

$$\sin(\beta_{Min}) = n_2 / n_1 \tag{1}$$

α_{Max} is the largest angle the fiber can accept. The Numerical Aperture, NA, of the light guide, describes this maximum angle:

$$NA = n \sin (\alpha_{Max}) = \sqrt{n_1^2 - n_2^2} \quad (2)$$

All angles, $\alpha \leq \alpha_{Max}$ or $\beta \geq \beta_{Min}$, will be transmitted by the fiber with larger angles resulting as leaky modes (by refraction at the core/clad interface).

2.3 Guided Light Outside the Core Medium

Clad fibers are an absolute necessity for transmitting light over long distance. If no cladding would be used, the environment (atmosphere, gases, dirt) would be the cladding material. Absorption would drastically reduce the transmitted luminous flux. One should note that for total internal reflection, a portion of the energy in the electric field penetrates medium 2 (evanescent field, Figure 4). Typically the penetration depth is 5 times the respective wavelength.

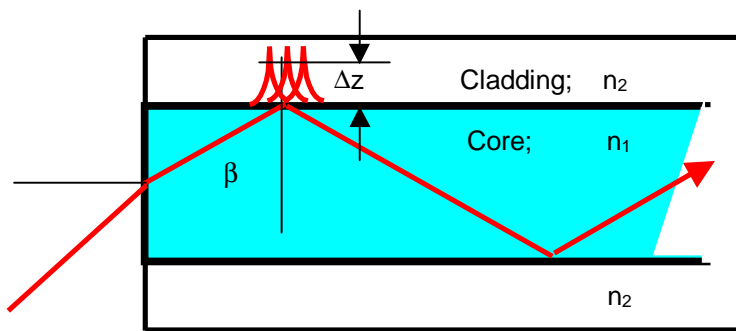

Fig. 4: The electromagnetic field penetrates the cladding glass at the point of total internal reflection. The penetration depth is Δz

To simplify matters, subsequent mathematical descriptions of light transmission in waveguides are related to planar waveguide-configurations.

Equation (3) gives the penetration depth of a electromagnetic wave (transverse) in medium n_2 (for planar lightguides):

$$\Delta z = \frac{\lambda n_1}{2\pi \sqrt{NA^2 - n_1^2 \cos^2(\beta)}} \quad (3)$$

Should β reach the critical angle for total internal reflection (1), the penetration depth Δz becomes ∞ . If $\beta = 90^\circ$, then $\Delta z = \lambda n_1 / (2\pi NA)$. The fact that a portion of the energy is transmitted in the cladding places certain demand on the cladding material. Further, it should be noted that the reflected wave experiences a phase shift dependent on β .

2.4 Phase Shift of Total Reflection

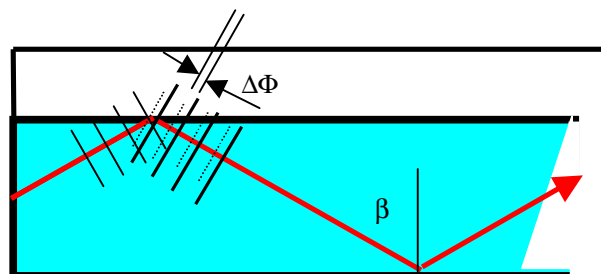

Fig. 5: Phase Shift, $\Delta\Phi$, after Total - Reflection

The phase shift, immediately after the reflection, causes the sine wave of the spreading ray to wander with the same periodicity (frequency) (Fig. 5). The phase shift, $\Delta\Phi(\beta)$, repeats every 2π .

Figure 5 schematically shows the phase shift for transversal electric wave modes (TE-Modes):

$$\Delta\Phi(\beta) = -2 \arctan \left[\frac{\sqrt{\sin^2(\beta) - (n_2/n_1)^2}}{\cos(\beta)} \right] \quad (4)$$

For the sake of completeness, it should be stated that transversal magnetic wave modes (TM) exist orthogonal to the electric wave modes (TE). Hence, for a mode number n there are two propagation wave modes (TE_n and TM_n). Equivalent relationship exists for (3) and (4) modified for TM wave modes.

3 Light Guide Modes

3.1 The Mode Equation

A typical model for light transmission in the fiber core is a zigzag pattern. Every zigzag configuration has an angle pair, designated (α ; β), which is also called a mode. For the existence of such modes, electromagnetic wave theory requires waves to interfere constructively with each other (Light amplification by superposition).

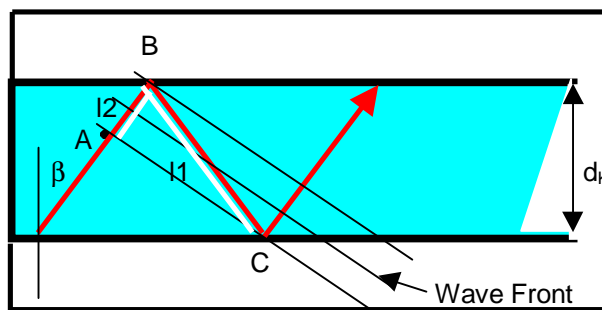

Fig. 6. Propagation within the light guide should produce the same amplitude at point A and point C (i.e. a maximum). The thickness of the propagating film is d_k .

In order to construct wave superposition, it is important that points A and C have the same wave amplitude (maximum or minimum). This is also means that over length l_1+l_2 , the wave period and phase shift of the wave front over 2 reflections of $\Delta\Phi$ produce the same amplitude as at point A. Expressed in phase space, this means that the phase difference between A and C be a whole multiple of 2π ($\Delta = 2\pi m$; $m=0,1,2\dots$). The phase delay over l_1+l_2 is therefore:

$$\Delta = \frac{4\pi}{\lambda} d_k n_1 \cos(\beta) + 2 \Delta\Phi = 2\pi m; \quad \text{for } m=0,1,2\dots \quad (5)$$

This equation is the fundamental condition for propagation of a wave in planar wave guides (thin film with cladding) of order m . This is also referred to as the **Mode Equation**.

If definite values of d_k , n_1 and λ are inserted into (5), due to the integer values of m , the angle β is not a free variable as in geometric optics. Rather a **discreet series of angles** β_m of order m results with a discreet number of modes.

In light guiding optics, the angle β and the core index of refraction n_1 are characteristic parameters for light propagation. Equation (6) formulates an associated **effective index of refraction** for a propagating mode:

$$N = n_1 \sin(\beta) \quad \text{where} \quad \beta_{\text{Min}} < \beta \leq \pi/2 \quad (6)$$

Figure 7 is a graph of the first 4 TE modes in a planar wave guide as a function of core thickness. For a thickness of, for example, 2 μm only modes m = 0 to m = 3 are possible for the given parameters. As an aside, the associated TM modes are also present, but not shown.

Figure 7 :
Diagram of Mode existence
(Dispersion-Relation)

Graph of film thickness as a function of effective index of refraction (or as a function of angle β where $N = n_1 \sin(\beta)$) shows which TE modes can exist for given material and design parameters.

Per (6) and (1) the effective index varies between n_2 and n_1 . This means every N corresponds to a fixed angle β.

The smallest film thickness for each mode d_F (= **Cut-Off-Thickness**) is also shown in the Diagram for $N = n_2$.

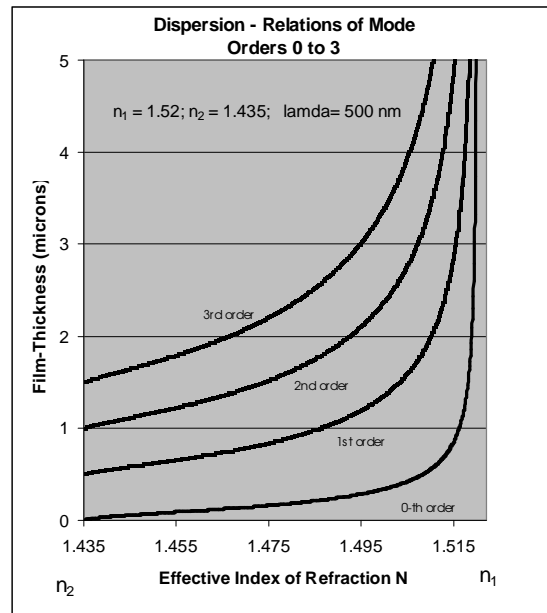

3.2 Mode Number of a Light Guide

If one attempts to define the angle increment, δ , from the mode equation (5) and (6), this describes the angle difference between modes. For $N \Rightarrow n_1$ with $\Delta\Phi \Rightarrow \pi/2$ and a defined film thickness (note $\sin\alpha = n_1 \cos\beta$):

$$\delta = \lambda / (2d_F) \quad (7)$$

The number of modes in a light guide can therefore be estimated based on the valid aperture angle, α [dimensions in radians; from $NA = \sin(\alpha)$], evenly distributed over the incremental angles. We therefore obtain:

$$M \cong 2(\alpha / \delta) = 4d_F \alpha / \lambda \quad (8)$$

As shown in Fig. 7, for planar light guides and a film thickness of 2 μm, there are 8 modes (4 TE modes and 4 TM modes). For cylindrical light guides, the principle of superposition for mode propagation is practically the same as for planar light guides. The number of modes propagating in a fiber light guide is given by a configuration parameter called the **V-Parameter**. This calculated value is:

$$V = \pi D_F / \lambda \sqrt{n_1^2 - n_2^2} = \pi D_F NA / \lambda \quad (9)$$

D_F ... Fiber diameter

For cylindrical fibers the number of modes is:

$$M_{F0} \cong V^2 / 2 \quad (10)$$

The same result as (10) is obtained in (12) if one takes the incremental angle difference between two neighboring modes with

$$\delta_{F0} = 2\lambda / (\pi D_F) \quad (11)$$

calculating the number of modes M as

$$M_{F0} \cong 2 (\alpha / \delta_{F0})^2 \quad (12)$$

Example:

A fiber with a 50 μm core diameter and NA = 0.5 (λ = 500 nm) has a V-Number V = 157.079. According to (9) - (12) there exists $M_{F0} \cong 12337$ Modes.

4 Light Intensity Distribution in a Light Guide

Phenomena logically, one can interpret the intensity distribution of light for the simplest case of a 0th order mode (m=0), ie.in a planar light guide with the superposition of two rays of the same mode. The interference of two rays produce interference stripes in the spatial superposition zone with a distance Λ between stripes

$$\Lambda = \lambda / (2 n \sin(\beta)) \quad (13)$$

n ... Index of refraction of propagating medium; λ ... Wavelength
In the following picture is an example of a two ray interference pattern.

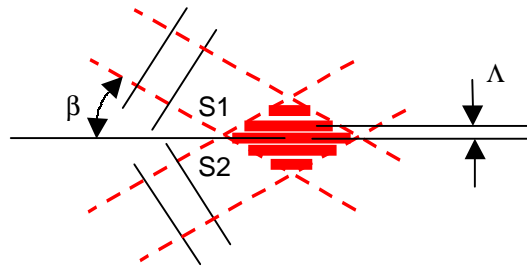

Fig. 8: Two ray interference with interference pattern

In a planar light guide, symmetrical rays of the same mode interfere, resulting in a periodic interference pattern. The intensity of the rays will be greatest in the areas of the light guide where the principle portion of wave energy in the propagating core is the greatest. In a light guide with a single propagating mode, the above described two ray interference results is a single intensity stripe. The intensity falls off going from the core to the edge. One expects a Gaussian intensity distribution, I_0 (see Fig. 9). The superposition of different modes results in an intensity distribution with one or more zero intensity nodes over the core cross section.

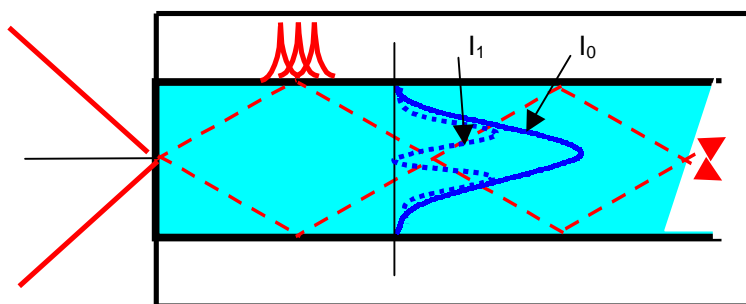

Figure 9. Interference in a light guide; the superposition zone is concentrated in the light propagating volume.

The exact solutions for the electromagnetic field components are the solutions of the Maxwell equations from which the intensity distribution can be derived.

For cylindrical fibers, the principle superposition is the same as for planar light guides. Due to the cylindrical geometry, the solutions of Maxwell's equations for wave propagation are Bessel functions. Out of these sets of solutions, the field components can be determined. They are divided into 3 electric, and 3 magnetic components. They are designated as circularly symmetric modes, TE_{0n} and TM_{0n} , as well as non-circularly symmetric modes, EH_{lm} and HE_{lm} .

The following table shows mode configurations and the possible number of modes. Fiber diameters and wave lengths are contained in the V number

V-Number	Mode-Configuration	Total Number Modes
0 - 2.4048	He ₁₁	2
2.4048 - 3.8317	TE ₀₁ , TM ₀₁ , He ₂₁	6
3.8317 - 5.1356	HE ₁₂ , EH ₁₁ , HE ₃₁	12
5.1356 - 5.5201	EH ₂₁ , HE ₄₁	16
5.5201 - 6.3802	TE ₀₂ , TM ₀₂ , He ₂₂	20
6.3802 - 7.0156	EH ₃₁ , HE ₅₁	24
7.0156 - 7.5883	HE ₁₃ , EH ₁₂ , HE ₃₂	30
7.5883 - 8.4172	EH ₄₁ , HE ₆₁	34
etc.		

Field components and number of modes as a function of the V-Parameter

From the table, one can see that for fibers with $V < 2.4048$, only one fundamental mode can be transmitted. The fundamental mode is comprised of two eigenmodes which differ only by their polarization. Such fibers are known as **Single-Mode-** or **Mono-Mode-Fibers**.

5 Fundamentals and Properties of Optical Fibers

5.1 Fiber Types

Waveguides are classified, on the one hand by the index of refraction profile of the core material, and on the other hand by the mode propagating ability. As was previously suggested, there are therefore single mode and multimode fibers.

In classifying the index of refraction profile, we differentiate between step index, gradient index and special profile fibers. Step index fibers have a constant index profile over the whole cross section. Gradient index fibers have a non-linear, rotationally symmetric index profile, which falls off from the center of the fiber outwards (Fig. 10).

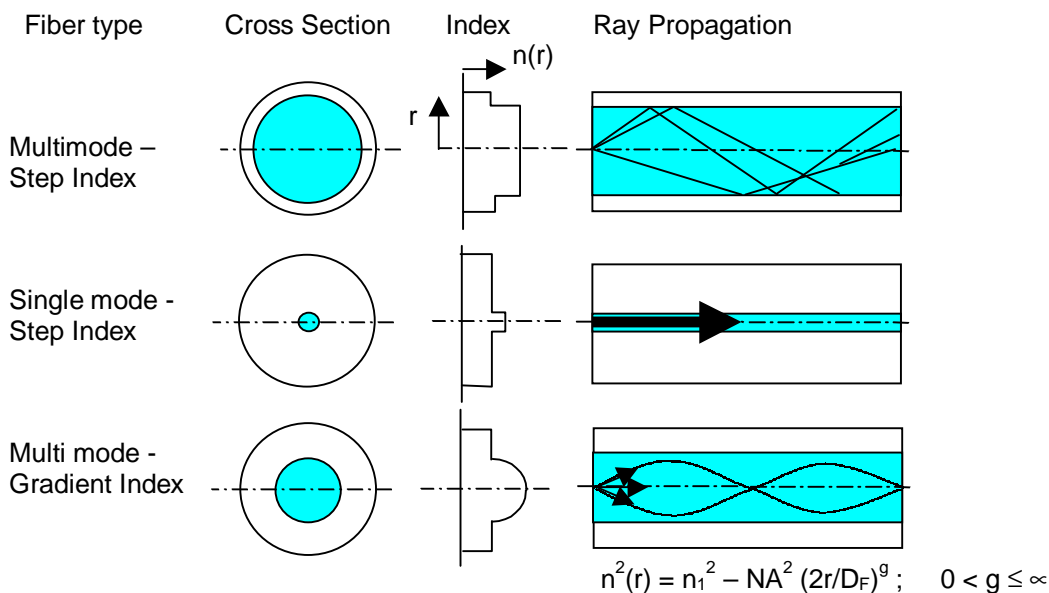

Figure 10: Overview of fundamental fiber types

In the case of step index, multimode fibers the index of refraction is constant, therefore the profile parameter $g = \infty$. For gradient index fibers, the index of refraction is reduced from the middle outwards. As opposed to travelling in a straight line, the rays travel in a spiral form around the optical axis.

5.2 Loss Mechanisms in Fibers

The following effects can lead to losses in electromagnetic energy propagating in fibers: material absorption, material scattering, waveguide scattering due to form-inhomogeneities, mode losses due to fiber bending and cladding losses.

5.2.1 Material-Absorption

Absorption losses are largely due to impurities in glass material from residual foreign atomic substances and hydrogen/oxygen molecules. Lastly, there are attenuation maxima in small band wavelength regions. The fundamental attenuated wavelength (highest absorption) is due to $(OH)^-$ ions. In quartz this is at $\lambda = 2.7 \mu\text{m}$. In the spectral region below this wavelength, there are other absorption bands at $1.38\mu\text{m}$, $1.24\mu\text{m}$, 950 nm and 720 nm .

Between these wavelength bands there are "windows" of minimal attenuation. These spectral regions are at 850nm (1st windows), at 1300 nm (2nd window) and at 1550 nm (3rd window). These spectral regions are used for data transmission (communication technology).

Foreign substances include metal ions such as Cr^{3+} , Fe^{2+} and Cu^{2+} . The associated absorption bands are between 500nm and 1000 nm . The bandwidth can be very different depending on the specific glass and metal ion being discussed.

Attempting to transmit short wavelength light in quartz fibers (ie. UV light $\lambda = 210 \text{ nm}$) can lead to a damage mechanism referred to as **solarisation**. In the quartz structure, there are absorption centers where anions (negatively charged ions) are replaced by an electron. These electrons can be excited, potentially at resonance. These regions in the crystal are also called **color centers**, because the normally color neutral crystals (ie. NaCl) become characteristically discoloured.

5.2.2 Material Scattering

One crucial scattering mechanism is **Rayleigh Scattering**. Spatially there are high density gradients (short compared to the wavelength) which alter the index of refraction and cause scattering. The intensity of the scattered light is proportional to $1/\lambda^4$. The effect evidences itself in, among other things, strong reverse scattering.

Another scattering mechanism is **Mie Scattering**, which mainly results in forward scattering. This mechanism comes from material inhomogeneities in larger wavelength spectrums.

Stimulated Raman Scattering and **Stimulated Brillouin Scattering** are non-linear radiation induced effects, which exceed intensity thresholds. Transmitting laser light alone can exceed these threshold values.

5.2.3 Light Guide Specific Scattering Mechanisms

So called **intrinsic fiber characteristics** can cause loss of energy. Some of these effects are: changes in core diameter, difference in refractive indices, index profile effects, mode coupling (double mechanisms) and scattered radiation in the cladding glass. Radiation losses can exist due to the conversion of core modes to non-propagating modes (cladding modes). This results in a reduction in the carrying modes.

Extrinsic causes for loss mechanisms come from such things as mechanical influences, such as micro and macrobending.

5.2.4 Radiation Losses due to Macrobending

Fiber bending with a constant bend radius is referred to as macrobending. This produces at least 2 loss mechanisms:

a) In multimode fibers, the number of propagating modes is reduced as a function of bend radius according to the following description:

$$M(R) \cong M_0 (1 - D_F n_2^2 / (R NA^2)) \quad (14)$$

M_0 ... number of propagating modes without bending
 $M(R)$... number of propagating modes with bending; n_2 ... clad refractive index
 R ... bend radius; D_F ... fiber diameter; NA ... numerical aperture

The percent of light decoupled (mode leakage) is:

$$\Delta M/M \cong D_F n_2^2 / (R NA^2) \times 100 (\%) \quad (15)$$

From (15) it can be seen that to minimize mode losses, fibers with small diameters and high numerical apertures are best suited.

b) An additional problem worth mentioning in bent fibers is electromagnetic radiation loss by differences in propagation (wave front) velocity

The main portion of electromagnetic energy is concentrated in the fiber core, while other portions are transmitted in the cladding and a slight amount outside the cladding.

In bending the fiber with bending radius R , the light will move with the medium's propagation velocity. In the fiber cross section, the area radially further from the radius center will need to move with a greater velocity than that of the fiber core to maintain the signal transport speed. At reaching a critical value, z_{kr} , a barrier is reached. The speed of light in a medium can not exceed its natural value $c = c_0/n_M$ (with $c_0 = 2.9979 \cdot 10^8$ m/s and n_M .. index of refraction for Medium M). The transport velocity lies beyond this point. Seeing as the signal velocity no longer exists, light can no longer be transmitted in this configuration and relevant portion of the energy radiates into the surroundings.

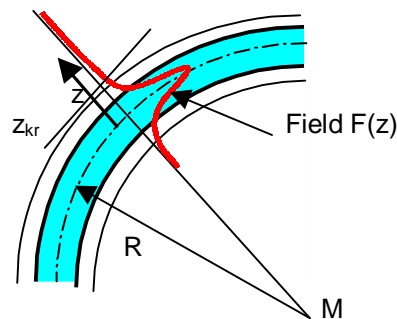

Figure 11:

Bent fiber with bend radius R .

The field on the far side of the center bend radius reaches the speed of light at distance z_{kr} .

As a result, light is radiated.

In this way, losses exist resulting in higher attenuation. For multimode fibers, this effect is relatively small when compared to the effect described in a). However, this type of attenuation does more seriously affect single mode fibers as bending is applied. For single mode fibers the reduction coefficient is calculated by:

$$\alpha_B = (c_1/\sqrt{R}) \exp(-c_2 R) \quad (16)$$

c_1, c_2 ... constants depending on fiber manufacture and wavelength. The stronger the electromagnetic field of transmitted modes out of the core, the more pronounced this effect.

Modes of longer wavelength lead to larger field expansion, which should be taken into account in given cable configurations.

5.2.5 Losses due to microbending

Along the length of the fiber, periodic or statistically distributed locations of curvatures occur, whose magnitude continuously varies. The associated loss mechanism is mainly exhibited by a permanent transformation of the transmitted mode.

5.2.6 Fiber Coupling Losses

Cleaved single fibers may be spliced. The splicing region can exhibit intrinsic (purely optical) and extrinsic (mechanical alignment) losses. The following diagram shows various configurations and transmission values for multimode fibers with cleaved terminations.

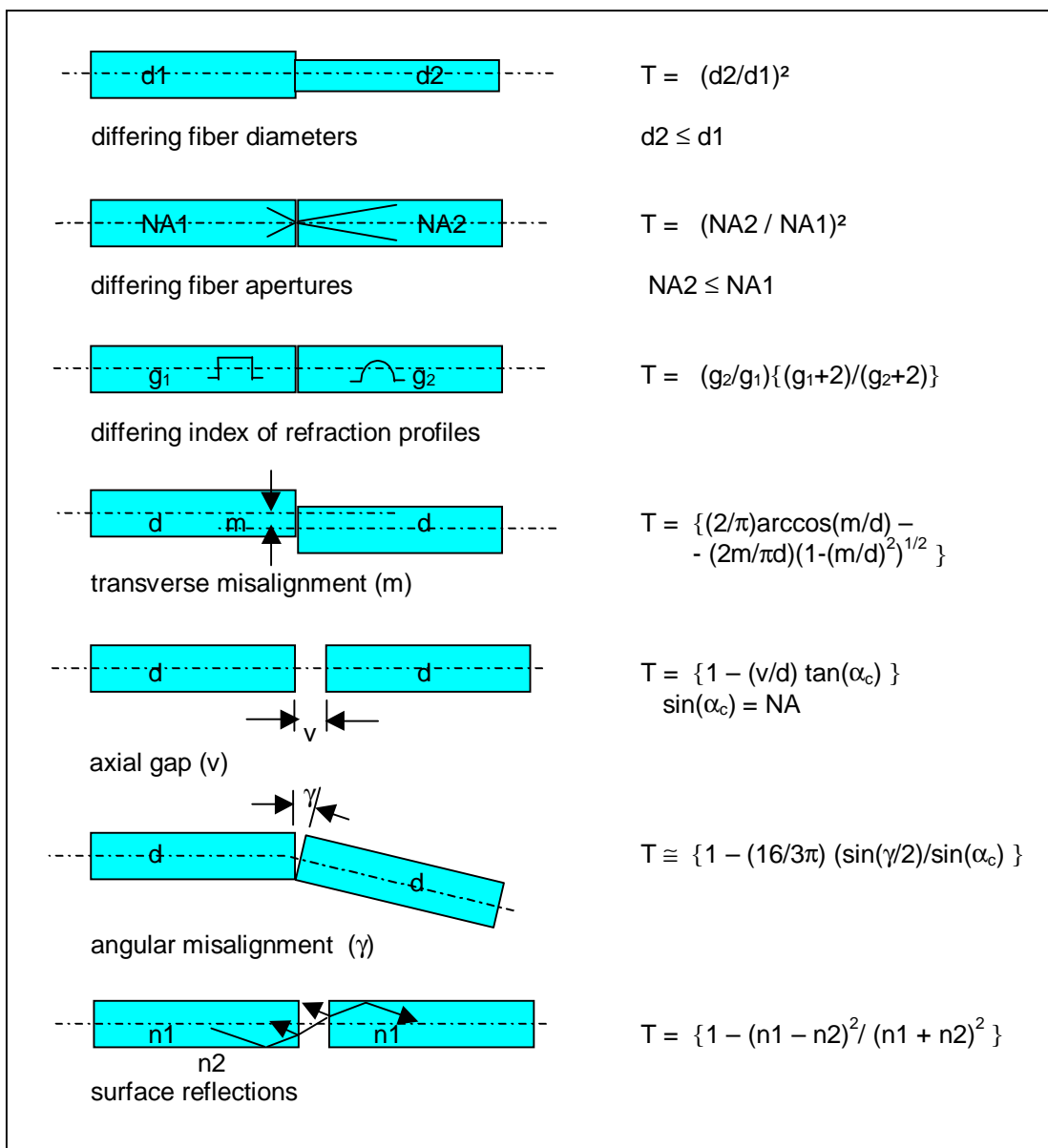

6 Transit Time Behaviour of Light in Light Guide

When short pulses of light energy are coupled into a fiber, the time behaviour is strongly influenced by the fiber type, as well as the core and cladding materials. Transit time differences will lead to a limitation of bandwidth, chiefly for telecommunication technology. In light transmission technology this effect is called dispersion. There are 2 basic types of dispersion:

- a) Mode dispersion
- b) Chromatic Dispersion :
 - Material dispersion
 - Light guide dispersion

6.1 Mode dispersion

Mode dispersion comes from differing transit times for different modes due to differing **optical paths** (zig-zag patterns multiplied by index of refraction). This is obviously only for multimode fibers. Single mode fibers propagate only one mode, which has only one path and therefore no path difference or transit time difference.

Gradient index fibers theoretically have the same optical path for all modes. Due to the decreasing index of refraction from the core to the cladding interface, light rays travel faster the closer they are to the interface. So different modes travel in different spiral paths. Lower modes have a shorter path, as they propagate nearer the optical axis, but are also in a larger index material. Higher mode modes have a longer path length, but travel in lower index material. The product of "path length and index of refraction" is constant. Transit time differences are therefore greatly compensated for in gradient index fibers.

6.2.1 Chromatic Dispersion – Material Dispersion

The refractive indices of the core and cladding are wavelength dependent. This means the differing wavelengths travel in the same medium with differing refractive indices. As the velocity in the medium is given by $v(\lambda) = c/n(\lambda)$ (c ... speed of light in vacuum, n ... refractive index of medium), it varies with varying wavelength. A light pulse with spectral bandwidth $\Delta\lambda$, leads to a transit time difference Δt . In digital communication, lasers generating short pulses are used.

6.2.2 Chromatic Dispersion - Light Guide Dispersion

As a result of the differing refractive indices between core and cladding, and their associated wavelength dependence, light in light guides travels with differing velocities. Together with material effects, a light guide will have spectral transit time variations. Careful material selection can limit transit time differences for specific wavelength regions.

7 Emitted Mode Radiation of Fibers

In principle, the radiated energy of a fiber is enclosed in the fibers aperture angle 2α (Fig.12). Loss mechanism, which reduce the number of modes in the fiber core (ie. Macrobending), limit the presence of higher modes. The radiated angle is therefore smaller than the specified aperture angle.

In bent cylindrical fibers, the first order approximation of the effective numerical aperture, NA^* , is from (9), (10) and (14):

$$NA^* = \sin(\alpha^*) = \sqrt{n_1^2 - n_2^2(1 + D_{Fo}/2R)^2} \quad (18)$$

Various scattering processes in the core (Rayleigh or Mie Scattering) can convert a portion of the light power from lower modes to higher modes and therefore "fill" the specified numerical aperture. Generally, the rule for the radiated angle characteristics of straight multimode fibers is: output light aperture, NA_{out} , equal or less than that of the light coupled in the fiber, NA_{in} , provided

NA_{in} does not exceed the aperture of the fiber NA_{Fiber} . In Fig. 12, the essential characteristics for radiating multimode fiber are shown.

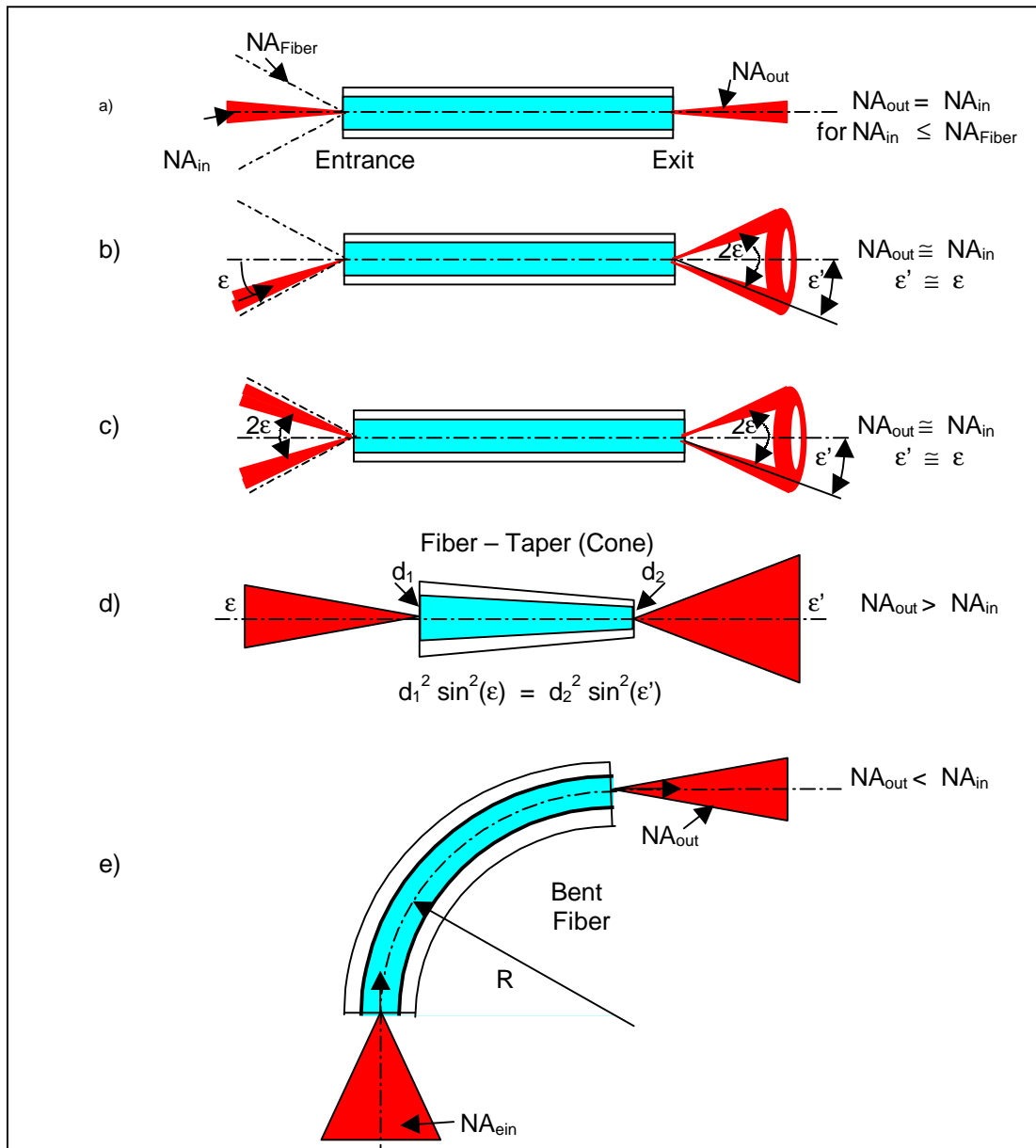

Figure 12. Relation of a fiber's radiated angle to different input angle distributions. In case b) asymmetric input coupling leads to symmetric output coupling. In d) a fiber with varying cross section (taper) changes the numerical aperture

8 Characteristics of Fiber Bundles

Many fibers gathered together into a bundle of diameter d_B , will maintain the essential properties of single fibers.

8.1 Emitted Radiation Characteristics of Bundles

A fiber bundle displays the same characteristics with regard to emitted radiation as a single fiber. Skewing the fiber arrangement off the bundle axis can influence radiated emission characteristics. Twisting fibers in the outer part of the bundle cross section can accept an inhomogeneous input distribution and create an even output distribution (Fig. 13b)

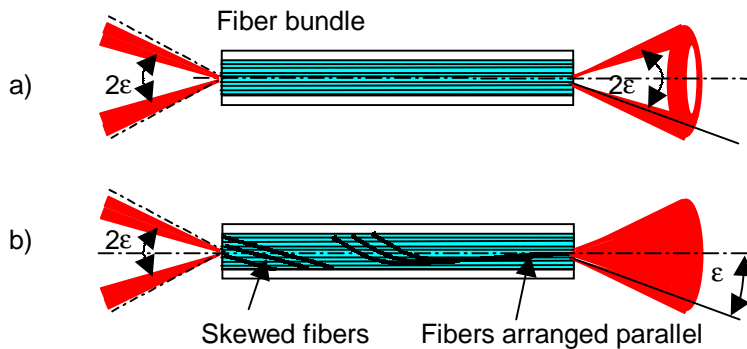

Figure 13: Various output characteristics with the same input.

This is possible because the direction of skewed fibers is close to the direction of the coupled light at the input. As a consequence, after refraction and the bundle entrance, rays coupled into the fiber can propagate with the same orientation as the optical axis.

The light in skewed fibers has a maximum intensity at 0° , i.e. on the fiber axis. Seeing as the fibers at the bundle exit are parallel to the bundle axis, the otherwise expected intensity minimum along the bundle axis is compensated for (Fig. 13a).

8.2 Losses in Fiber Bundles

In principle, all previously discussed loss mechanisms in single fibers apply to fiber bundles.

The fibers are closely packed and epoxied together. This leads to 2 additional losses, which are only relevant to bundles: **interstitial spacing** and **cladding losses**.

In Fig. 14, both these spatial transmission losses (interstitial and cladding losses) are depicted

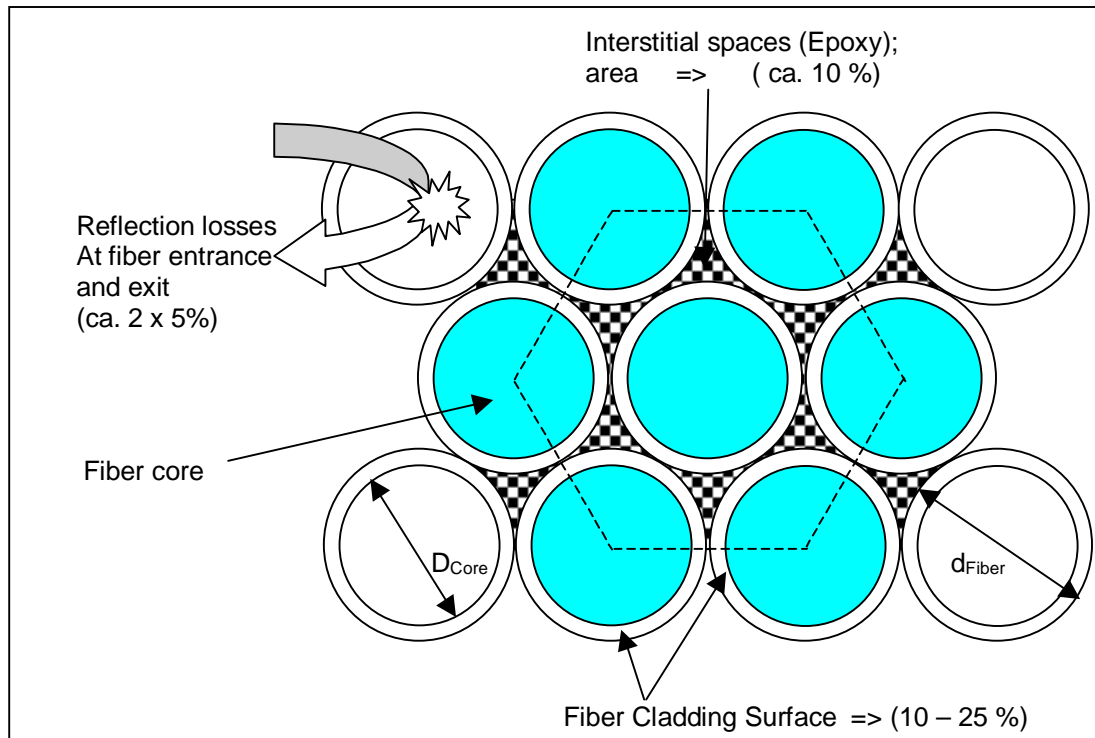

Figure 14. Cross section of a fiber bundle. Diagram of bundle specific sources of losses

A special process of thermally forming the bundle ends is possible. The interstitial spaces are therefore reduced and the transmission increased by ca. 10%.

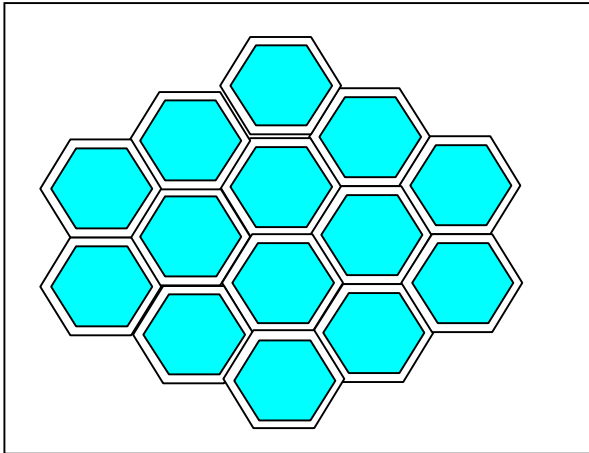

Figure 15 :

Thermally forming the fiber ends yields a hexagonal structure of the single fibers.

The fibers rigidly adhere to each other

(Cross Section)

8.3 Fiber Bundle Transmission

Fiber transmission infers the relationship between output luminous flux of the fiber and the input luminous flux, where the input aperture is smaller or equal to that of the fiber ($NA_{input} \leq NA_{Fiber}$).

The European measurement fixture and protocol for measuring transmission values of fiber optics established in DIN 58141 (Part 2)

Figure 16 shows the measurement principle.

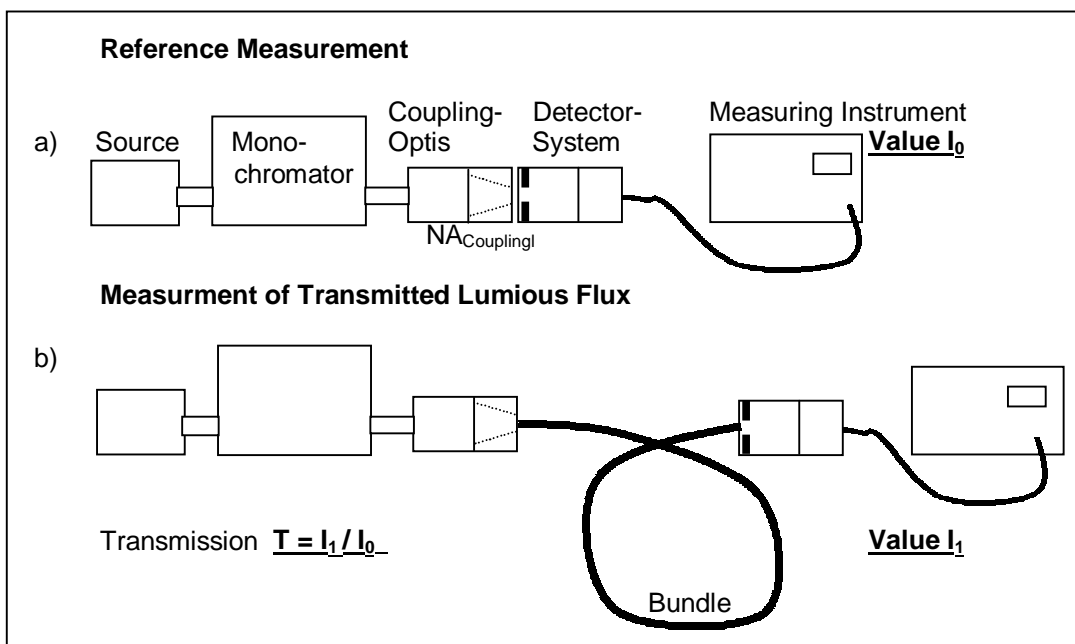

Figure 16. Hardware configuration for fiber optic transmission measurement (DIN 58141 T2)

With single fibers, one can suitable couple light into the fiber core without surface losses due to the cladding.

In this case, the main causes of losses are scattered modes, absorption or fiber bending. Typically the transmission values over length of 1m for a single fiber are ca. 90%.

Transmission in fiber bundles is subject to the above mentioned surface loss, with a typical transmission budget of :

Cladding loss \approx 15-20%; packing fraction loss \approx 12%;

Reflection losses \approx 10%; Attenuation \approx 0.1 db/m ($\Delta T \approx$ 1-3%/m depending on λ)

Total Transmission => T \approx 60%

From the transmittance, $Q(\lambda)$, of the core glass at various wavelengths, the spectral transmission of the fiber bundle as a function of length can be calculated from.

$$T(\lambda) = P (d_K/d_M)^2 R Q(\lambda)^L \quad (19)$$

where P = packing fraction (ca. 0.85); R = reflectivity (ca. 0.92); L = fiber length (mm) / 25 or in inches; d_M = cladding diameter ; d_K = core diameter; $Q(\lambda)$ = transmittance (for 25 mm glass thickness) i.e.. 0.998 for $\lambda = 600$ nm.

With the above mention parameters and core/clad diameter ratio $d_K/d_M = 0.91$ gives T = 60 %. Following is a transmission plot for a fiber bundle (l = 1m,4m, active bundle diameter d=3mm)

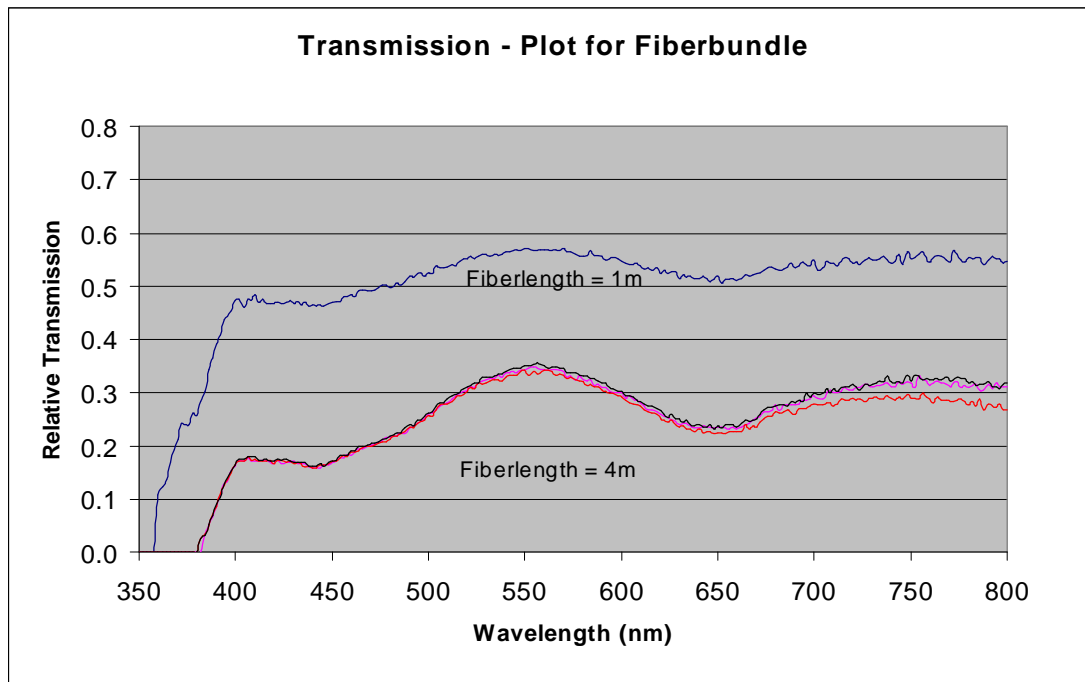

Figure 17. Fiber Bundle transmission curve (l = 1m,4m; d = 3 mm; NA = 0.55)

Scatter and absorption mechanisms are strongly dependent on fiber length as well as wavelength. The spectral transmission goes like $Q(\lambda)^L$ according to (19). This is the reason why glass and plastic fibers are strongly attenuated in blue wavelength region. For glass fibers, a different choice of glass quality can improve transmission in the blue (blue enhanced fibers)

The attenuation in a fiber is length dependent, and described in decibels (db), defined by the following relation:

$$d = 10 (L_1 - L_0) \log (\Phi (L_1) / \Phi(L_0)) \quad \text{where } L_1 > L_0 \quad (20)$$

$\Phi(L_1)$, $\Phi(L_0)$.. luminous flux of fiber length L_1 and L_0 (in m); d ... attenuation (db)
 where $D = d / (L_1 - L_0)$, the attenuation per Meter (db/m).

9 Fiber Optic Illumination

Thin fibers can be configured into illumination components of differing geometrical entrance and exit cross sections, according to desire or need. Usually, the input cross section is arranged to match that of the light source, which, as a rule, is circular.

9.1 Transforming Light Distribution

The geometry of the bundle input and output can be arranged to meet illumination needs. Geometries may square, rectangular, line shaped or several arms with outputs of different shapes and/or sizes. In this way fiber optic components can transform light distribution from one end to the other.



a) Fiber Optic Ringlight



b) 3 Arm Light Guide

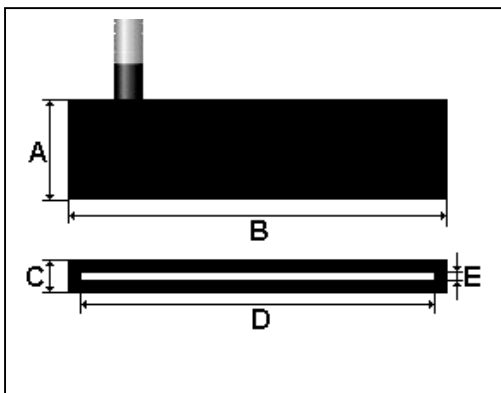

c) Bundle to Line Converter (sketch)

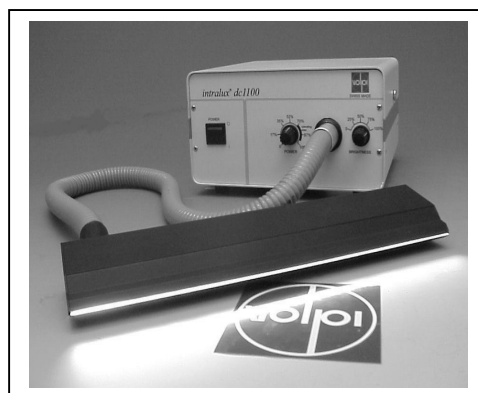

d) Line Converter with Light Source

Figure 18 : Examples of various fiber optic illumination components

This flexibility in configuring light is relatively simple with fibers, whereas classical optic solutions would be much more cumbersome or practically impossible.

9.2 Fibers as Isolators

A second additional advantage of fiber optics is the very small thermal and electrical conduction of glass fibers. It is possible to transmit light or detected signals with fibers in environments of high temperature and high electrical or magnetic fields.

9.3 Partitioning Luminous Flux with Fibers

Illumination and sensors often have very specific requirements. In the simplest case, it is desired to distribute the coupled light to multiple arms with either precisely the same or different specified amounts of luminous flux in each arm.

- in Multiarm Light Guides

Even distribution can be achieved by various **manual** fiber randomizing techniques. If very even light distribution between arms is required, **machine randomizing** techniques can also be employed.

Essentially three grades of randomising are offered; coarse, medium and fine. Randomizing is a description of the spatial mixing of fibers at the common end of partitioned fiber bundles, ie. a multiarm light guide.

- in Line Converters

In the following diagram, the distribution of fibers in a fiber line input and output are shown.

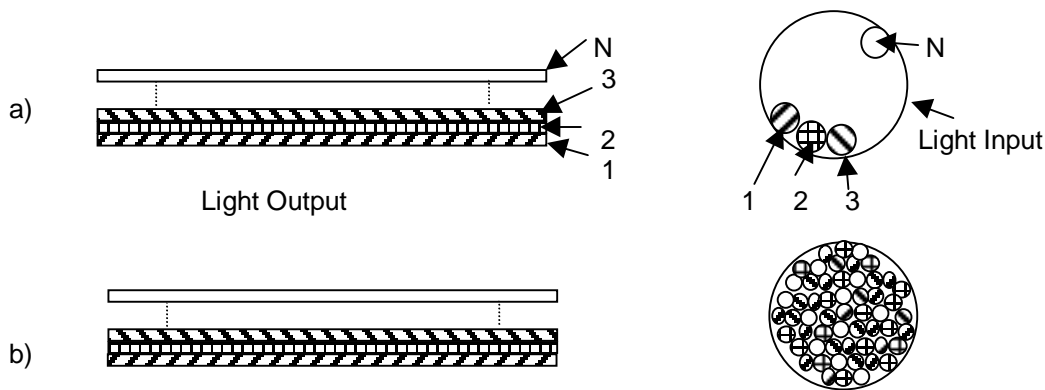

Figure 19. Possible fiber distributions or fiber randomizing for a line converter (sketch)
a) coarse randomization b) fine randomization

Figure 19 a) shows the arrangement of a stack of fiber lines. The fibers of each fiber line are gathered together at the input cross section. In b) the fiber from each fiber line are distributed in all quadrants of the input cross section. Inhomogeneities in the light source can be distributed over the length of the line (ref. a).

- in Sensor Light Guides

For applications in sensor technology, it is frequently desired to mix the sending fibers (carrying light to the object) and detector fibers (acquiring change in light condition) or to segregate in a distinct fashion. Following are some geometrical examples:

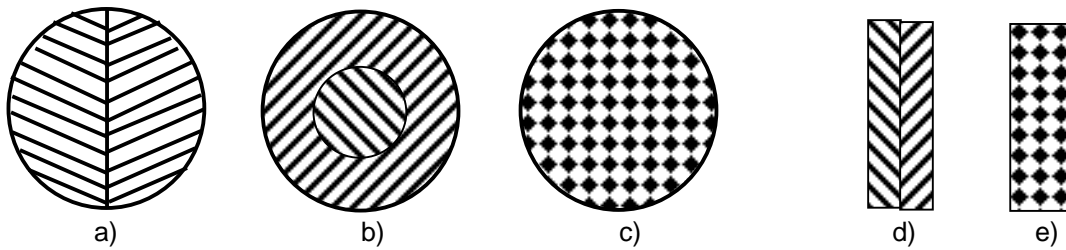

Figure 20. Segregated fiber cross sections a), b), and d). Sender/Receiver randomized c) and e).

9.4 Fiber Optic Sensor Applications

Many applications in industry, Chemistry and Medicine make use of non-invasive methods to diagnose or perform measurements. Diverse process parameters or relevant biomedical quantities can be obtained. The introduction of light, due to its propagation characteristics, its spectral composition and its different interaction with matter, opens up a wide variety of possibilities for the development of measuring devices. Some of these include; triangulation, high resolution imaging systems, CCD cameras, laser scanning, laser procedures with sensitive line scan cameras, spectrometry etc.

The basic elements of a sensor system typically are a light source, light delivery, object, light acquisition and detection (Fig. 21)

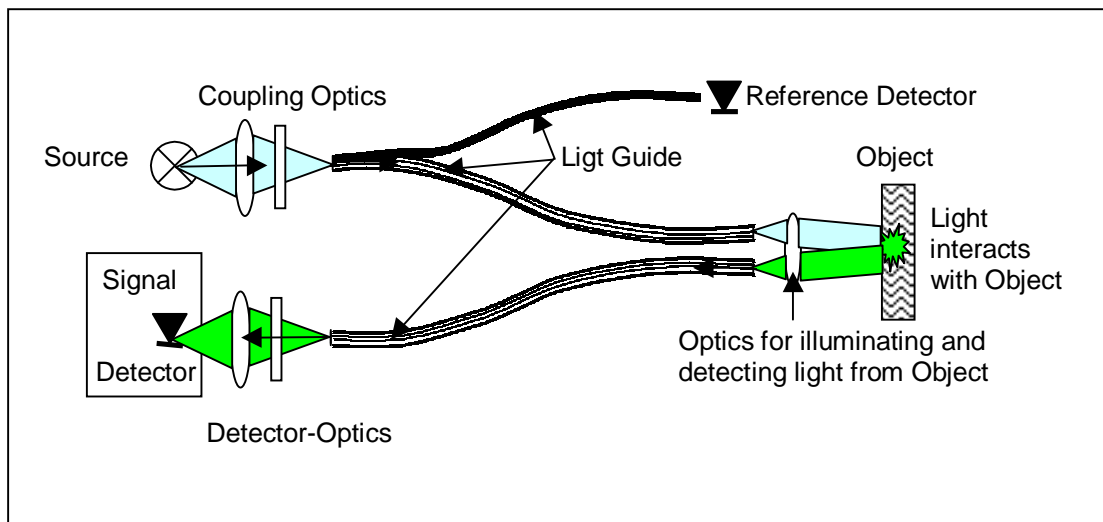

Figure 21. Configuration of a Fiber Optic Sensor System

The interaction of incident light falling upon an object leads to a change in electromagnetic parameters (i.e. absorption, polarization, scattering, etc.), which is detected by the system.

In sensor technology, the inspected object may be in various states (solid, liquid, gas or plasma) and in various surrounding conditions (test tubes, microtube, tilted surface, moving mechanical part etc.). There is as much variation in the required optical configuration, light delivery and detection.

Principally, measurements are made in one of three fashions; transmitted illumination, and two variations of incident illumination, direct and orthogonal. The method is matched to the particular type of detection, i.e. fluorescent measurement, scattering, etc.

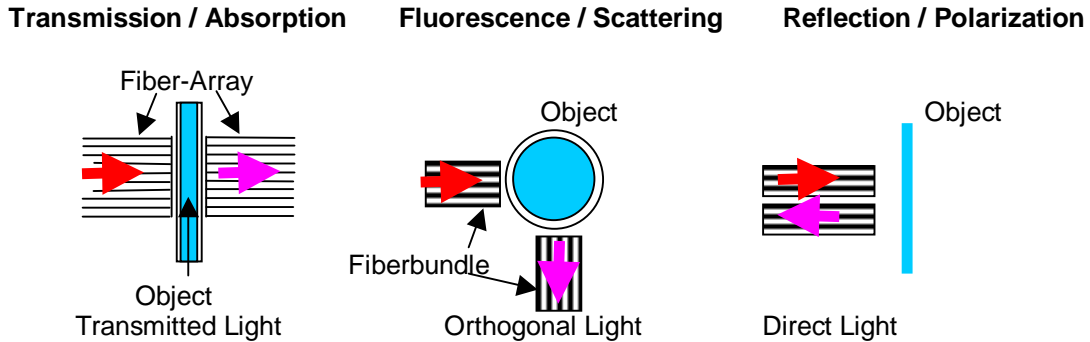

Figure 22. Fiber optic illumination and detection configurations

10 Overview of Common Fibers

Conventional and special fibers are used in sensor technology, having distinct transmission spectra. The following summary identifies the most important and most used fiber configurations.

10.1 Fiber for Producing Fiber Bundles

Fiber type Core	Clad	Ø Cladding (µm)	Numerical Aperture	T (° C)	Spectral Range (nm)
Glass	Glass	30; 50; 70; 100	0.55; 0.66; 0.72; 0.87	-30 – +130	380 - 1300
UV/Quartz IR / Quartz	UV/Quartz IR / Quartz	30; 50; 70; 100; 70; 110	0.22 0.22	-190 - +350 -190 - +350	200 - 1100 350 – 2400
Plastic	Plastic	100; 250	0.5	-30 - +80	400 – 700

Plastic fibers have lower transmission in certain spectral regions (higher UV- and IR absorption), when compared to glass. Furthermore, fluorescence sensors need to be applied with caution due to induced fluorescence in the fiber. Disturbing broadband signals can interfere with real measuring signals.

Thin glass and quartz fibers are commonly available in bundles. To reduce electrostatic build up and discharge, the fiber are coated with an **electrolytic agent**. The agent may be applied wet or dry.

As the electrolytic agent is composed of organic material, amongst other things, it's use has set temperature limits. Light guides for medical applications require repeated sterilization cycles of 145° C. Specific agents are used to accommodate such uses

Quartz fibers are protected with thin polymer coatings to improve mechanical performance and chemical resistance. For thin fibers bundled, this **buffer** is usually polyimide.

10.2 Single Fibers or Monofibers for Spectroscopy, Laser Light Propagation etc.

Fiber type Core	Clad	Ø Cladding (µm)	Numerical Aperture	T (° C)	Spectral Range (nm)
UV/Quartz	UV/ Quartz	100 bis 1000	0.12; 0.22 0.37; 0.4	-190 - +350	200 – 1100
IR/Quartz	IR / Quartz	100 bis 1000	0.12; 0.22 0.37; 0.4	-190 - +350	350 – 2400
UV/Quartz	Plastic	200 bis 2000	0.22; 0.4	-30 bis +150	220 - 700
IR /Quartz	Plastic	200 bis 2000	0.22; 0.4	-30 bis +150	400 – 2400

Transmission characteristic of quartz fibers are drastically influenced by water content (portion of OH⁻ ions) to the raw material. UV/VIS fibers may have ca. 500 – 600 ppm (OH)⁻, whereas VIS/IR fiber have as little as 5 ppm (OH)⁻.

To further protect fibers, an additional, or two additional coatings (buffer or jacket) may be applied to the fiber. Materials used are acrylate, nylon, tefzel or polyimide and for special requirements, metal coatings (aluminium or gold). Temperature requirements often dictate the choice of buffer. Examples are: acrylate fiber –40 to +85° C, nylon fibers to ca. +100° C, tefzel fibers to +150° C, and polyimide buffered fibers for use in –190 bis ca. +350° C environments. Extreme temperature ranges may call for aluminium jacketed fibers, –269° C to +400° C, or gold fiber, –269° C to ca. +750° C.

Quartz fibers with plastic PCS buffers (plastic clad silica) used for the first cladding will produce higher apertures than quartz, quartz fibers.

10.3 Fiber for Image Transmission

As mentioned in the historical overview, there were efforts early on to carry an image over optical fibers. The challenge and accompanying fascinating motive for these activities was possibility of using a flexible, manipulative optical instrument to acquire images of previously inaccessible objects. Medical applications were of special interest and proved to be an important goal and vital milestone in the development of such instruments.

Image transmitting fibers are principally made of single thin fibers which function as pixel points on both ends of the light guide. The difference between a normal fiber bundle and an image bundle is that single fibers have the same orientation with respect to each other on both coupled and emitting ends of the bundle. Said another way, a single fiber has the same geometrical arrangement on each end of the bundle. Such a light guide is referred to as a **coherent** fiber bundle or **image bundle**.

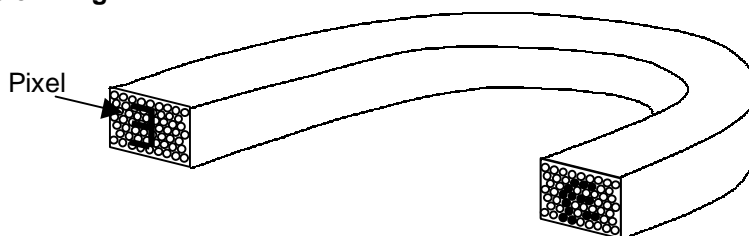

Figure 23. Sketch of a fiber optic image bundle

Nowadays, mainly 2 types of image bundles are used; flexible bundles and rigid bundles which are fused together over their whole length. The latter may be considered flexible when restricted to very small diameters, typically 0.2mm to 1.0mm outer diameters.

For so called flexible bundles, the coherent fiber arrangement of each end is fused. In between the end pieces, the fibers are free and therefore very flexible.

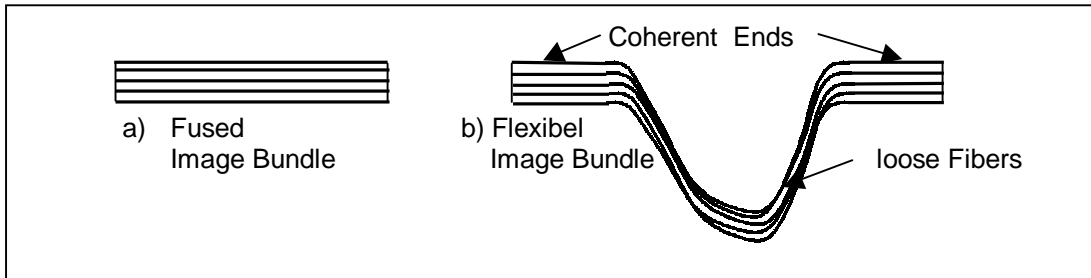

Figure 24. Image bundle configurations a) fused; b) flexible

The diameter of flexible pixel fibers are typically around 10 μm , where as fused bundles may have fibers of about 5 μm diameter.

In optical instruments i.e. flexible endoscopes, image bundles serve only as elements to transmit an image from the coupled end to the emitting end of the fiber bundle. On the object side of the bundle (the distal end of the optical instrument), a lens or lens system images the object onto the end of the bundle. On the emitting end (the proximal end), again a lens or lensing system projects the transmitted image either to a virtual image plane to be visualized by an ocular or to a video camera.

Figure 25 shows the schematic construction of a fiber optic endoscope

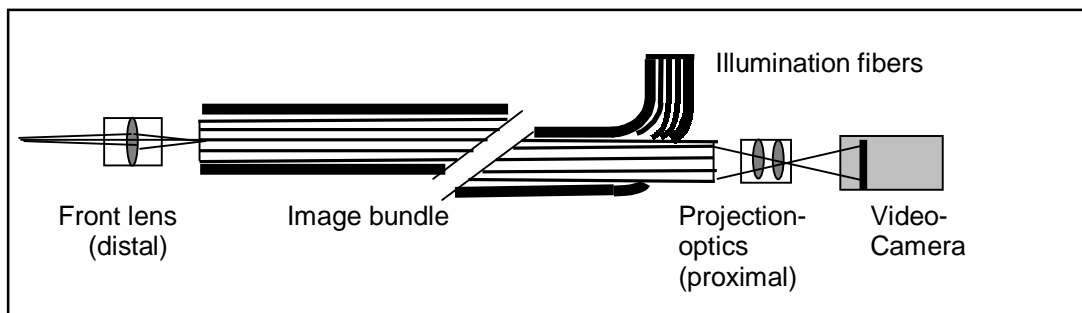

Figure 25. Principle construction of a fiber optic video endoscope

Typically there is a superposition of the imaged object structure with the ordered pixel structure of the image bundle. The optical resolution respectively the modulation transfer function (MTF) of the whole endoscopic system is effected. The MTF describes the contrast as a function of lines per mm.